

Female Header 1.27 mm

SMT Series

SPECIFICATIONS

- Current Rating: 1 A
- Insulator Resistance: 1000 MOhm min.
- Contact Resistance: 20 mOhm max.
- Dielectric Withstanding: AC 500 V
- Operating Temperature: -40°C ~ +105°C
- Soldering Temperature: 260°C for 3~5 sec. max
- Contact Material: Phosphor Bronze
- Insulator Material: Polyester, UL 94V-0
- Standard: Nylon-6T
- Finish: Tin, Gold or Duplex Plated
- Standard: Gold Flash all over
- Note: Duplex Plating: Gold Plated on contact area, Tin on solder area

F504-MGN-D034-XX-BT

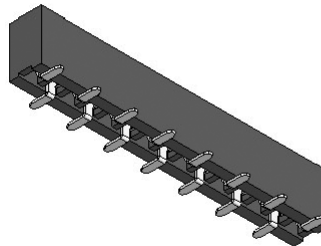

F504-MGN-D034-XX-AT

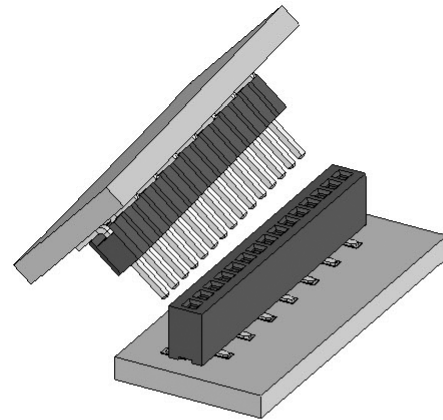
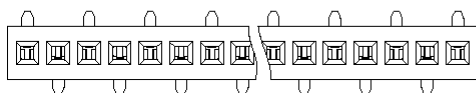
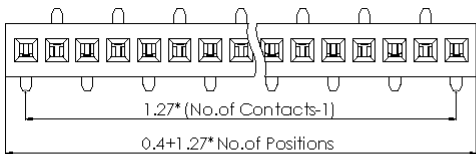
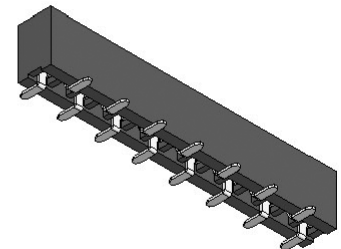

[F504] -XT

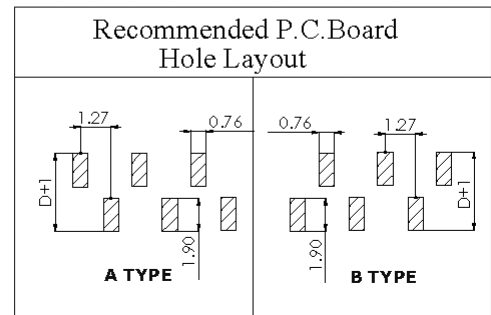
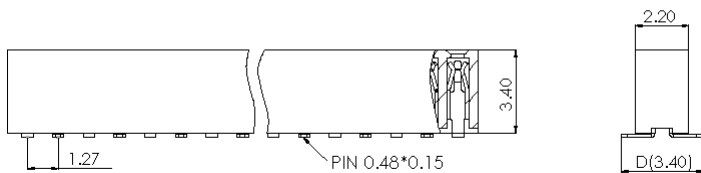

How to order

Unit: mm

Series	Connector Type	Contact Plating	Material	Pin Length mm	Number of Contacts	Other
FXXX	- X	X	X -	DXXX	- XX	- XT
F504:F/H 1.27 H:3.40 Single Row	M:SMT Type	G:Gold Flash T: Tin Plated A:10U"Gold B:15U"Gold C:20U"Gold ©Duplex Plating D:Gold Flash/Tin (Standard:G)	N:Nylon-6T (Standard:N)	M-D D034	(02 TO 40 Contacts)	AT:A TYPE BT:B TYPE